

Environmental Product Declaration



In accordance with ISO 14025 and EN 15804:2012+A2:2019 for:

Aqua plasterboard

from



Programme:

Programme operator:

EPD registration number:

Publication date:

Valid until:

The International EPD® System, www.environdec.com

EPD International AB

S-P-07028

2022-10-26

2027-10-25

An EPD should provide current information and may be updated if conditions change. The stated validity is therefore subject to the continued registration and publication at www.environdec.com

General information

Programme information

Programme:	The International EPD® System
Address:	EPD International AB Box 210 60 SE-100 31 Stockholm Sweden
Website:	www.environdec.com
E-mail:	info@environdec.com

CEN standard EN 15804 serves as the Core Product Category Rules (PCR)
Product category rules (PCR): Construction Products, PCR 2019:14. Version 1.11.
PCR review was conducted by: The Technical Committee of the International EPD® System. See www.environdec.com/TC for a list of members.
Independent third-party verification of the declaration and data, according to ISO 14025:2006: <input type="checkbox"/> EPD process certification <input checked="" type="checkbox"/> EPD verification
Third-party verifier: Verifier accredited by The International EPD® System Name: Patxi Hernandez Individual verifier E-mail: patxi@aureaconsult.com Approved by: The International EPD® System
Procedure for follow-up of data during EPD validity involves third-party verifier: <input checked="" type="checkbox"/> Yes <input type="checkbox"/> No

The EPD owner has the sole ownership, liability, and responsibility for the EPD.

EPDs within the same product category but from different programs may not be comparable. EPDs of construction products may not be comparable if they do not comply with EN 15804. For further information about comparability, see EN 15804 and ISO 14025.

Company information

Owner of the EPD: Gypfor S.A

Contact: Bernardo Pessanha- info@gypfor.com - Gypfor S.A - +351269098278 - <http://www.gypfor.com>

Description of the organisation:

Gypfor operates one of most recent production unit of gypsum plasterboard in the Iberian Peninsula. With an installed capacity of 18 million m² per year, this unit produces a wide range of gypsum plasterboards with different specifications, to deliver its clients solutions for works and projects using gypsum board with the most suitable characteristics. Strategically located near an important logistic hub, the port of Sines, the proximity to main roads and good shipping accessibilities allows a sustainable and economical distribution of its products.

Gypfor has implemented a Quality Management System according to ISO 9001 and all products are produced and certified according to EN 520, guaranteeing a quality product according to international market requirements.

Gypfor is also committed with its goals on sustainability in industrial production. Specific measures to reach these goals include prioritizing recycled raw materials such as paper, wood stick pallets and waste board, having nearly 20% of electricity used in production generated by renewable solar energy, using a fleet of 100% electric forklifts in its operations, and providing its people with solutions for EV charging.

- QUALITY POLICY: ISO 9001:2015

Name and location of production site: the declared section Aqua plasterboard is produced by Gypfor S.A. The production plant is in:

GYPFOR, Gessos Laminados SA.
Zona Industrial Logística de Sines,
Zona 10, lote E8
7520-309 Sines
Portugal

Product information

Product Name: Aqua Plasterboard

Product description:

The GYPFOR AQUA board is suitable for indoor drywall applications on ceilings, partitions, wall linings and other generic application elements. Enhanced quality board designed for applications where extra moisture resistance is required, such as kitchens, bathrooms, laundries, public bathrooms in hospitals, hotels, and schools. It can be used in applications that require direct mechanical attachment to wood or metal structures in or pasted with adhesives. It should not be applied at temperatures above 52 degrees Celsius (125 degrees Fahrenheit) for prolonged periods of time, or in areas with extreme humidity. To maintain GYPFOR AQUA performance integrity, the drywall plasterboard should be protected from exposure to adverse conditions during storage and construction.

Suitable for application in :

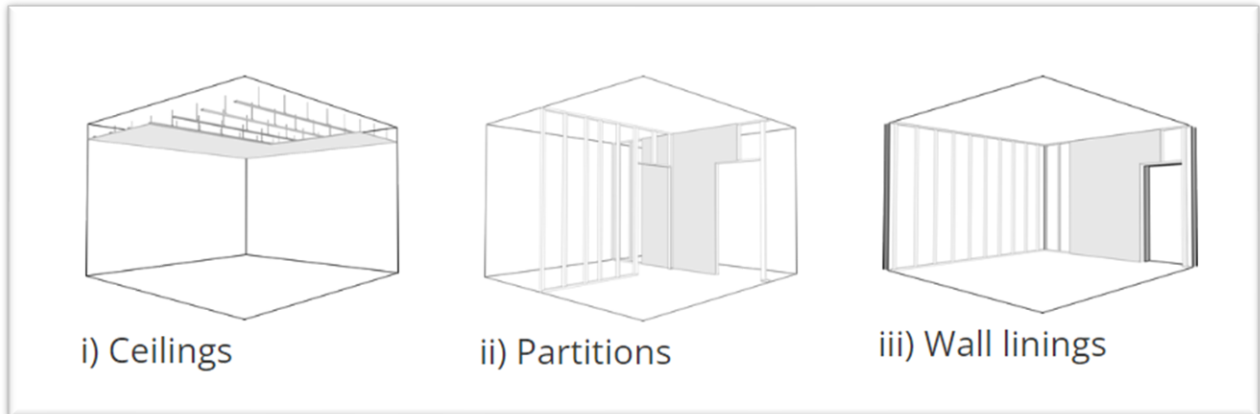

Technical description, and applicable standards:

Type of board	H1	EN 520
Reaction to fire	A2-s1, d0	EN 520
Resistance to vapor water	10	EN ISO 10456
Thermal conductivity (W/m.°C)	0.25	EN ISO 10456
Density (kg/m ³)	≥ 660	No applicable

More information about the product is available at: gypfor.com

UN CPC code: 547 Building completion and finishing service

LCA information

Declared unit: 1 m² of Aqua plasterboard BA13 of 12,5mm thickness.

Reference service life: 50 years regarding lifetime of plasterboards when applied at normal conditions.

More information <https://gypsum.org/life-cycle-resources>

Time representativeness: primary data from the manufacturing site and the electricity mix of the electricity supplier refer to the year 2021.

Database(s) and LCA software used: Ecoinvent v3.8 (allocation, cut-off by classification) database and SimaPro 9.3 software have been used for the LCA calculations. LCA methods used are EN 15804:A2 compliant.

Cut off rules: More than 95% of the data for total upstream inflows and the central module have been included

Allocation: Production, energy and waste data have been assigned based on physical criteria of mass

Description of system boundaries:

Cradle to gate with options, modules C1-C4, module D and with optional modules A4-A5 and B1-B7. The modularity and the polluter payer principles have been followed.

The following processes have been excluded:

- Flows related to human activities such as employee transport
- The construction of plants, production of machines and transportation systems, and maintenance activities.

The following describes the production process:

The production process is divided into two parts: calcination and formation. In the first stage of the process, the raw material, calcium sulfate or gypsum ($\text{CaSO}_4 \cdot 2\text{H}_2\text{O}$), is grinded into the desired particle size and partially dehydrated using heat to form stucco ($\text{CaSO}_4 \cdot \frac{1}{2} \text{H}_2\text{O}$) and stored as a powder on vertical silos. The second stage of the process takes advantage of the properties of the stucco, which is easily malleable, and if mixed with water in the right proportions, can return to its original crystalline form and regain its hardening properties of gypsum. The stucco is then mixed with water and other additives and extruded with a special paper sheet on each side, resulting in a board shape. The production line is specially designed so that the stucco is completely rehydrated before cutting into the desired length. After this phase, the boards enter a dryer to remove the excess water and accelerate the mineralization process of gypsum. Exiting the dryer, the board is trimmed into the final dimensions and palletized.

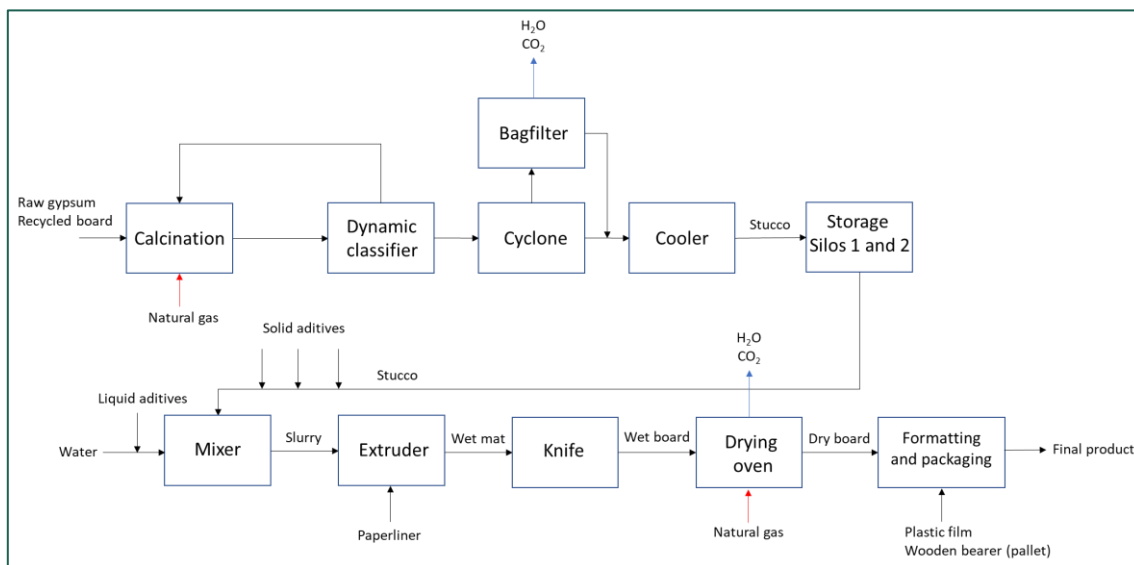

As permitted by EN 15804, the results of stages A1-A3 have been grouped into a single product stage (A).

A1. Raw Material Supply

- Extraction and processing of raw materials (Mineral gypsum, additives, starch, among others))
- Generation of electricity and heat from primary energy resources
- Processing up to the end-of-waste state or disposal of final residues, including any packaging not leaving the factory gate with the product.

A2. Transportation

- External transportation to the core processes and internal transport.

A3. Manufacturing

- Manufacturing of the construction product and co-products.
- Production of ancillary materials or pre-products.
- Treatment of waste generated from the manufacturing processes. They are processing up to the end-of-waste state or disposal of final residues, including any packaging not leaving the factory gate with the product.

A4. Transport

- Transportation from the production gate to the construction site

SCENARIO INFORMATION	VALUE/DESCRIPTION
Vehicle type used for transport	Long-distance truck Transoceanic ship
Vehicle load capacity	Truck: 32 tones
Fuel type and consumption	Truck:31,1L/100 km Ship: 0,0014L/100 TnKm
Distance to the construction site	Truck: 445,92 km Ship: 507,68
Capacity utilisation (including empty returns)	Percentage assumed in Ecoinvent
Bulk density of transported products	8,70 Kg/m2 (including packaging)
Volume capacity utilisation factor	1

A5. Construction Installation:

The product is directly transferred from the truck to the construction site.

SCENARIO INFORMATION	VALUE/DESCRIPTION
Ancillary materials for installation	Metalic frame (4) Screws (21) Paste (0,54)
Water use	Not used
Other resource use	Not required
Quantitative description of the energy type and consumption during the preparation and installation process	Not used
Direct emissions to ambient air, soil and water	-
Waste materials on the building site, generated by the product's installation	No generation
Output materials as a result of waste processing at the construction site	Product waste

B1 – B7. No material use or energy consumption is required during the use stage of the products under study.

C1. Deconstruction/demolition

- The impact has been considered.

C2. Transport

- Transportation of the discarded product accounts for part of the waste processing, e.g. to a recycling site and transportation of waste.

C3. Waste processing for reuse, recovery and/or recycling

- It is considered that there is no recycling or reuse at the end of the product's life because, during the demolition of buildings, there is no selective separation of materials in the vast majority of cases. Consequently, the impact is considered 0.

C4. Disposal

- Waste disposal, including physical pre-treatment and management of the disposal site. According to the "polluter pays principle, emissions from waste disposal are considered part of the product system under study and, therefore, part of this module.

SCENARIO INFORMATION	VALUE/DESCRIPTION
Collection process specified by type	The product is collected completely mixed with the construction waste.
Recovery system specified by type	0 Kg intended for reuse 0 Kg intended for recycling 0 Kg intended for energy recovery
Disposal specified by type	Disposal to landfill
Assumptions for scenario development (e.g. transport)	A lorry of the size class 16-32 metric tons gross and Euro VI emissions class Diesel Fuel consumption: 25,5 l/100 Km Distance: 50 km

Scenarios included in A4-A5 and C1-C4 are currently in use and represent one of the most probable alternatives.

D. Reuse-recovery-recycling potential

This product has no considerable benefits due to recycling or/and reuse.

System diagram:

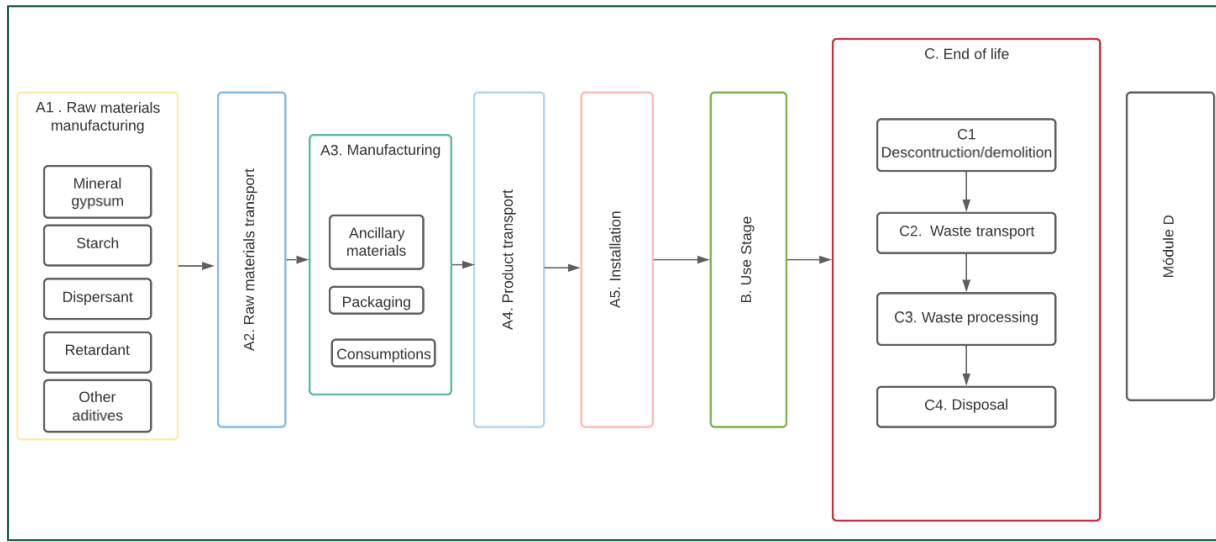

More information:

- The underlying LCA study has been carried out by Isolana Energética
- The study covers at least 95% of the materials and energy per module and at least 99% of the total use of materials and energy of each unit process.
- More information about the product is available at: gypfor.com

Modules declared, geographical scope, the share of specific data (in GWP-GHG indicator) and data variation:

	Product stage			Construction process stage		Use stage							End of life stage				Resource recovery stage	
	Raw material supply	Transport	Manufacturing	Transport	Construction installation	Use	Maintenance	Repair	Replacement	Refurbishment	Operational energy use	Operational water use	De-construction demolition	Transport	Waste processing	Disposal	Reuse-Recovery-Recycling-potential	
Module	A1	A2	A3	A4	A5	B1	B2	B3	B4	B5	B6	B7	C1	C2	C3	C4	D	
Modules declared	X	X	X	X	X	X	X	X	X	X	X	X	X	X	X	X	X	X
Geography	GLO	GLO	PT	EU	EU	EU	EU	EU	EU	EU	EU	EU	EU	EU	EU	EU	EU	
Specific data	>90% GWP-GHG					-	-	-	-	-	-	-	-	-	-	-	-	-
Variation – products	Variation of the impact products declared < 10% - for each product group					-	-	-	-	-	-	-	-	-	-	-	-	-

Content information declared unit

Product components	Weight, kg	Post-consumer material, weight-%	Renewable material, weight-%
Mineral gypsum	6 – 10	0	0
Recycled plasterboard	0,8 – 1,0	10%	0
Plasterboard liner	0,2 - 0,4	0	100%
Starch	0,02 - 0,04	0	100%
Dextrose	0,02 -0,03	0	0
Dispersant	0,010 - 0,020	0	0
Retardant	0,001 - 0,002	0	0
Surfactant	0,002 - 0,003	0	0
Other aditives	0,01 - 0,02	0	0
Water-repelent additive 1	0,02 - 0,05	0	0
Water-repelent additive 2	0,0040 - 0,0060	0	0
Packaging materials	Weight, kg	Weight-% (versus the product)	
Wooden pallets	0,04	<1%	
Film PE	0,01		

During the life cycle of the products no hazardous substance listed in the "Candidate List of Substances of Very High Concern (SVHC) for authorisation" has been used in a percentage higher than 0,1% of the weight of the product.

Environmental Information

Aqua plasterboard BA13

Potential environmental impact – mandatory indicators according to EN 15804

Results per declared unit																
Indicator	Unit	Tot. A1-A3	A4	A5	B1	B2	B3	B4	B5	B6	B7	C1	C2	C3	C4	D
GWP-fossil	kg CO ₂ eq.	2,01 E+00	7,32 E-01	3,23 E-01	0,00 E+00	0,00 E+00	0,00 E+00	0,00 E+00	0,00 E+00	0,00 E+00	0,00 E+00	7,73 E-02	3,76 E-02	0,00 E+00	3,67 E-02	0,00 E+00
GWP-biogenic	kg CO ₂ eq.	- 1,33 E-01	7,47 E-04	- 6,40 E-03	0,00 E+00	0,00 E+00	0,00 E+00	0,00 E+00	0,00 E+00	0,00 E+00	0,00 E+00	1,04 E-03	4,00 E-05	0,00 E+00	1,68 E-04	0,00 E+00
GWP-luluc	kg CO ₂ eq.	2,19 E-03	2,61 E-04	2,06 E-04	0,00 E+00	0,00 E+00	0,00 E+00	0,00 E+00	0,00 E+00	0,00 E+00	0,00 E+00	2,71 E-06	1,41 E-05	0,00 E+00	8,26 E-06	0,00 E+00
GWP-total	kg CO ₂ eq.	1,88 E+00	7,33 E-01	3,17 E-01	0,00 E+00	0,00 E+00	0,00 E+00	0,00 E+00	0,00 E+00	0,00 E+00	0,00 E+00	7,83 E-02	3,77 E-02	0,00 E+00	3,69 E-02	0,00 E+00
ODP	kg CF ₁₁ eq.	2,67 E-07	1,81 E-07	3,18 E-08	0,00 E+00	0,00 E+00	0,00 E+00	0,00 E+00	0,00 E+00	0,00 E+00	0,00 E+00	1,74 E-08	9,39 E-09	0,00 E+00	1,82 E-08	0,00 E+00
AP	mol H ⁺ eq.	9,65 E-03	3,54 E-03	1,45 E-03	0,00 E+00	0,00 E+00	0,00 E+00	0,00 E+00	0,00 E+00	0,00 E+00	0,00 E+00	8,40 E-02	1,20 E-04	0,00 E+00	3,60 E-04	0,00 E+00
EP-freshwater	kg P eq.	7,16 E-05	4,97 E-06	1,21 E-05	0,00 E+00	0,00 E+00	0,00 E+00	0,00 E+00	0,00 E+00	0,00 E+00	0,00 E+00	7,74 E-08	2,69 E-07	0,00 E+00	2,34 E-07	0,00 E+00
EP-freshwater	kg PO ₄ ³⁻ eq.	2,20 E-04	1,53 E-05	3,70 E-05	0,00 E+00	0,00 E+00	0,00 E+00	0,00 E+00	0,00 E+00	0,00 E+00	0,00 E+00	3,03 E-04	8,24 E-07	0,00 E+00	7,18 E-07	0,00 E+00
EP-marine	kg N eq.	2,59 E-03	8,13 E-04	3,30 E-04	0,00 E+00	0,00 E+00	0,00 E+00	0,00 E+00	0,00 E+00	0,00 E+00	0,00 E+00	3,32 E-03	2,64 E-05	0,00 E+00	1,36 E-04	0,00 E+00
EP-terrestrial	mol N eq.	2,68 E-02	9,04 E-03	3,65 E-03	0,00 E+00	0,00 E+00	0,00 E+00	0,00 E+00	0,00 E+00	0,00 E+00	0,00 E+00	6,06 E-03	2,93 E-04	0,00 E+00	1,49 E-03	0,00 E+00
POCP	kg NMVOC eq.	6,20 E-03	3,05 E-03	1,30 E-03	0,00 E+00	0,00 E+00	0,00 E+00	0,00 E+00	0,00 E+00	0,00 E+00	0,00 E+00	3,81 E-09	1,16 E-04	0,00 E+00	4,27 E-04	0,00 E+00
ADP-minerals & metals*	kg Sb eq.	6,73 E-06	1,66 E-06	3,21 E-06	0,00 E+00	0,00 E+00	0,00 E+00	0,00 E+00	0,00 E+00	0,00 E+00	0,00 E+00	1,09 E+00	9,00 E-08	0,00 E+00	7,17 E-08	0,00 E+00
ADP-fossil*	MJ	3,37 E+01	1,18 E+01	4,21 E+00	0,00 E+00	0,00 E+00	0,00 E+00	0,00 E+00	0,00 E+00	0,00 E+00	0,00 E+00	3,98 E-04	6,13 E-01	0,00 E+00	1,19 E+00	0,00 E+00
WDP*	m ³	7,85 E-01	3,87 E-02	8,27 E-02	0,00 E+00	0,00 E+00	0,00 E+00	0,00 E+00	0,00 E+00	0,00 E+00	0,00 E+00	7,21 E-11	2,11 E-03	0,00 E+00	3,76 E-03	0,00 E+00

Acronyms	GWP-fossil = Global Warming Potential fossil fuels; GWP-biogenic = Global Warming Potential biogenic; GWP-luluc = Global Warming Potential land use and land use change; ODP = Depletion potential of the stratospheric ozone layer; AP = Acidification potential, Accumulated Exceedance; EP-freshwater = Eutrophication potential, fraction of nutrients reaching freshwater end compartment; EP-marine = Eutrophication potential, fraction of nutrients reaching marine end compartment; EP-terrestrial = Eutrophication potential, Accumulated Exceedance; POCP = Formation potential of tropospheric ozone; ADP-minerals&metals = Abiotic depletion potential for non-fossil resources; ADP-fossil = Abiotic depletion for fossil resources potential; WDP = Water (user) deprivation potential, deprivation-weighted water consumption
-----------------	---

* Disclaimer: The results of this environmental impact indicator shall be used with care as the uncertainties of these results are high or as there is limited experience with the indicator.

Potential environmental impact – additional mandatory and voluntary indicators

Results per declared unit																
Indicator	Unit	Tot. A1-A3	A4	A5	B1	B2	B3	B4	B5	B6	B7	C1	C2	C3	C4	D
GWP - GHG ₁	kg CO ₂ eq	1,98 E+00	7,2 6E-01	3,1 3E-01	0,00 E+00	0,00 E+00	0,00 E+00	0,00 E+00	0,00 E+00	0,00 E+00	0,00 E+00	7,6 6E-02	3,7 3E-02	0,00 E+00	3,6 1E-02	0,00 E+00

Disclaimers shall be added, if required by EN 15804.

Use of resources

Results per declared unit																
Indicator	Unit	Tot. A1-A3	A4	A5	B1	B2	B3	B4	B5	B6	B7	C1	C2	C3	C4	D
PERE	MJ	5,77 E+00	1,44 E-01	4,85 E-01	0,00 E+00	0,00 E+00	0,00 E+00	0,00 E+00	0,00 E+00	0,00 E+00	0,00 E+00	4,59 E-02	7,79 E-03	0,00 E+00	2,42 E-02	0,00 E+00
PERM	MJ	0,00 E+00	0,00 E+00	0,00 E+00	0,00 E+00	0,00 E+00	0,00 E+00	0,00 E+00	0,00 E+00	0,00 E+00	0,00 E+00	0,00 E+00	0,00 E+00	0,00 E+00	0,00 E+00	0,00 E+00
PERT	MJ	5,77 E+00	1,44 E-01	4,85 E-01	0,00 E+00	0,00 E+00	0,00 E+00	0,00 E+00	0,00 E+00	0,00 E+00	0,00 E+00	4,59 E-02	7,79 E-03	0,00 E+00	2,42 E-02	0,00 E+00
PENRE	MJ	3,67 E+01	1,25 E+01	4,51 E+00	0,00 E+00	0,00 E+00	0,00 E+00	0,00 E+00	0,00 E+00	0,00 E+00	0,00 E+00	1,16 E+00	6,50 E-01	0,00 E+00	1,26 E+00	0,00 E+00
PENRM	MJ	0,00 E+00	0,00 E+00	0,00 E+00	0,00 E+00	0,00 E+00	0,00 E+00	0,00 E+00	0,00 E+00	0,00 E+00	0,00 E+00	0,00 E+00	0,00 E+00	0,00 E+00	0,00 E+00	0,00 E+00
PENRT	MJ	3,67 E+01	1,25 E+01	4,51 E+00	0,00 E+00	0,00 E+00	0,00 E+00	0,00 E+00	0,00 E+00	0,00 E+00	0,00 E+00	1,16 E+00	6,50 E-01	0,00 E+00	1,26 E+00	0,00 E+00
SM	kg	0,00 E+00	0,00 E+00	0,00 E+00	0,00 E+00	0,00 E+00	0,00 E+00	0,00 E+00	0,00 E+00	0,00 E+00	0,00 E+00	0,00 E+00	0,00 E+00	0,00 E+00	0,00 E+00	0,00 E+00
RSF	MJ	0,00 E+00	0,00 E+00	0,00 E+00	0,00 E+00	0,00 E+00	0,00 E+00	0,00 E+00	0,00 E+00	0,00 E+00	0,00 E+00	0,00 E+00	0,00 E+00	0,00 E+00	0,00 E+00	0,00 E+00
NRSF	MJ	0,00 E+00	0,00 E+00	0,00 E+00	0,00 E+00	0,00 E+00	0,00 E+00	0,00 E+00	0,00 E+00	0,00 E+00	0,00 E+00	0,00 E+00	0,00 E+00	0,00 E+00	0,00 E+00	0,00 E+00
FW	m ³	2,54 E-02	1,34 E-03	2,53 E-03	0,00 E+00	0,00 E+00	0,00 E+00	0,00 E+00	0,00 E+00	0,00 E+00	0,00 E+00	1,37 E-04	7,28 E-05	0,00 E+00	1,43 E-03	0,00 E+00
Acronyms	PERE = Use of renewable primary energy excluding renewable primary energy resources used as raw materials; PERM = Use of renewable primary energy resources used as raw materials; PERT = Total use of renewable primary energy resources; PENRE = Use of non-renewable primary energy excluding non-renewable primary energy resources used as raw materials; PENRM = Use of non-renewable primary energy resources used as raw materials; PENRT = Total use of non-renewable primary energy resources; SM = Use of secondary material; RSF = Use of renewable secondary fuels; NRSF = Use of non-renewable secondary fuels; FW = Use of net fresh water.															

¹ The indicator includes all greenhouse gases included in GWP-total but excludes biogenic carbon dioxide uptake and emissions and biogenic carbon stored in the product. This indicator is thus equal to the GWP indicator originally defined in -EN 15804:2012 + A1.

Waste production and output flows

Waste production

Results per declared unit																
Indicator	Unit	Tot. A1-A3	A4	A5	B1	B2	B3	B4	B5	B6	B7	C1	C2	C3	C4	D
Hazardous waste disposed	kg	4,44 E-05	2,76 E-05	1,77 E-05	0,00 E+00	0,00 E+00	0,00 E+00	0,00 E+00	0,00 E+00	0,00 E+00	0,00 E+00	2,78 E-06	1,48 E-06	0,00 E+00	1,32 E-06	0,00 E+00
Non-hazardous waste disposed	kg	1,74 E-01	1,06 E+00	5,73 E-01	0,00 E+00	0,00 E+00	0,00 E+00	0,00 E+00	0,00 E+00	0,00 E+00	0,00 E+00	8,65 E+00	5,73 E-02	0,00 E+00	8,65 E+00	0,00 E+00
Radio active waste disposed	kg	5,73 E-05	8,00 E-05	1,10 E-05	0,00 E+00	0,00 E+00	0,00 E+00	0,00 E+00	0,00 E+00	0,00 E+00	0,00 E+00	7,98 E-06	4,15 E-06	0,00 E+00	8,00 E-06	0,00 E+00

Output flows

Results per declared unit																
Indicator	Unit	Tot. A1-A3	A4	A5	B1	B2	B3	B4	B5	B6	B7	C1	C2	C3	C4	D
Components for re-use	kg	0,00 E+00	0,00 E+00	0,00 E+00	0,00 E+00	0,00 E+00	0,00 E+00	0,00 E+00	0,00 E+00	0,00 E+00	0,00 E+00	0,00 E+00	0,00 E+00	0,00 E+00	0,00 E+00	0,00 E+00
Material for recycling	kg	0,00 E+00	0,00 E+00	0,00 E+00	0,00 E+00	0,00 E+00	0,00 E+00	0,00 E+00	0,00 E+00	0,00 E+00	0,00 E+00	0,00 E+00	0,00 E+00	0,00 E+00	0,00 E+00	0,00 E+00
Materials for energy recovery	kg	0,00 E+00	0,00 E+00	0,00 E+00	0,00 E+00	0,00 E+00	0,00 E+00	0,00 E+00	0,00 E+00	0,00 E+00	0,00 E+00	0,00 E+00	0,00 E+00	0,00 E+00	0,00 E+00	0,00 E+00
Exported energy, electricity	MJ	0,00 E+00	0,00 E+00	0,00 E+00	0,00 E+00	0,00 E+00	0,00 E+00	0,00 E+00	0,00 E+00	0,00 E+00	0,00 E+00	0,00 E+00	0,00 E+00	0,00 E+00	0,00 E+00	0,00 E+00
Exported energy, thermal	MJ	0,00 E+00	0,00 E+00	0,00 E+00	0,00 E+00	0,00 E+00	0,00 E+00	0,00 E+00	0,00 E+00	0,00 E+00	0,00 E+00	0,00 E+00	0,00 E+00	0,00 E+00	0,00 E+00	0,00 E+00

Information on biogenic carbon content

Results per declared unit		
BIOGENIC CARBON CONTENT	Unit	QUANTITY
Biogenic carbon content in product	kg C	6,42E-01
Biogenic carbon content in packaging	kg C	7,33E-02

Note: 1 kg biogenic carbon is equivalent to 44/12 kg CO₂.

On one hand, according to the “Results on impact categories” figure, in general terms by stages and their respective indicators, stages A1-A3 represent 57,14%, stages A4-A5 14,18% and 7,30%, respectively. Regard to stages C1, C2, and C4 represent 19,33%, 0,66% and 1,40%.

On the other hand, the product stage (A1-A3) is the most representative of the system, being the stage where most of the impacts are found. During this stage, 61,03% of the impacts associated with global warming, 65,43% of the impacts associated with using non-renewable resources, and 86,05% of the impacts associated with water consumption are produced. Finally, the total climate change impact over the product's life cycle is 3,08E+00 kg of CO₂ equivalent.

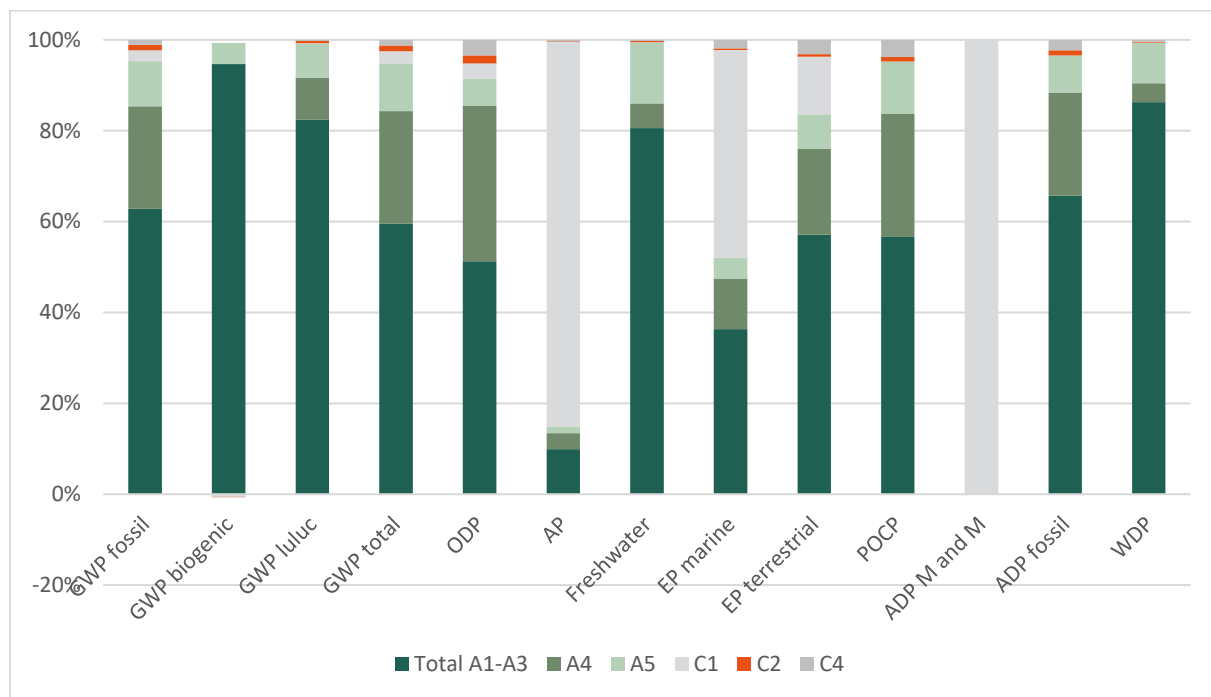

Results on impact categories

Information related to Sector EPD

- This is not a sector EPD.

Differences versus previous versions





- This is the first EPD

References

- General Programme Instructions of the International EPD® System. Version 3.01.
- PCR 2019:14 Construction products - version 1.11
- CEN (2019): EN 15804:2012+A2:2019, Sustainability of construction works – Environmental product declarations – Core rules for product category of construction products.
- ISO 14040:2006: Environmental Management-Life Cycle Assessment-Principles and framework.
- ISO 14044:2006: Environmental Management-Life Cycle Assessment-Requirements and guidelines.
- ISO 14025:2006: Environmental labels and declarations-Type III Environmental Declarations-Principles and procedures.
- ISO 14020:2000: Environmental labels and declarations — General principles.
- LCA Gypfor S.A

Annex I

Summary of results

Parameters		Environmental impacts					Total
		Product stage A1 / A2 / A3	Transport A4	Installation A5	Use B	End of life C	
	Global Warming Potential (GWP-Total) kg CO2 eq/UF	1,9	0,73	0,32	0,00	0,2	3,1
	Abiotic depletion potential ⁽¹⁾ (ADP-fossil fuels) – MJ/UF	33,7	11,8	4,21	0,00	2,9	52,6
	Energy consumption ⁽²⁾ – MJ/UF	42,5	12,7	5,0	0,00	3,1	63,2
	Water consumption ⁽³⁾ – m³/UF	0,03	0,001	0,003	0,00	0,002	0,03
	Waste production ⁽⁴⁾ – kg/UF	0,17	1,06	0,6	0,00	17,4	19,2

(1) This indicator corresponds to the parameter Abiotic Depletion Potential (fossil fuels).

(2) This indicator corresponds to total primary energy consumption (renewable + non-renewable).

(3) This indicator corresponds to the net use of freshwater resources.

(4) This indicator corresponds to the sum of waste (hazardous, non-hazardous and radioactive)

Annex II

Aqua plasterboards are produced in different format. While the 12,5mm thickness represents the majority of the production, the manufacturing process includes other thicknesses. To estimate environmental impacts for other thicknesses, results might be multiplied by their corresponding factor in the following table:

Aqua plasterboard			
Aqua BA13			
Thickness	Dimensions m ²	Weight kg/m ²	Conversion factor
12.5 mm	1,62	8,65	1
12.5 mm	2,4		
12.5 mm	2,64		
12.5 mm	3		
12.5 mm	3,12		
12.5 mm	3,24		
12.5 mm	3,36		
12.5 mm	3,6		
Aqua BA15			
15 mm	2,4	11,28	1,30
15 mm	2,64		
15 mm	3		
15 mm	3,12		
15 mm	3,6		
Aqua BA18			
18 mm	3	12,07	1,39
18 mm	3,6		



www.environdec.com